

IONIZER USER MANUAL

Model 2300

AirStat® Digital Ceiling Emitter Ionizer

Version 1.1



IONIZER USER MANUAL

Model 2300

AirStat® Digital Ceiling Emitter Ionizer

Version 1.1

Contents

1. Introduction	4
2. Ionization and Application	5
A. Ionization Theory	
B. Cleanroom Contamination Application	
C. ESD Control Application	
D. AC Ionization and Industrial Application	
3. Application Guide	7
A. Basic ESD Control	
B. Ionization for CDM/CBE Control	
4. Cautions and Personal Safety	8
A. Cautions	
B. Personal Safety	
5. Technical Specification	9
6. Drawings	10
7. Setup and Operation	10
A. Introduction	
B. Descriptions for Model 2300	
C. Descriptions for Model 6380	
D. Installation	
E. Powering the System	
F. Output Settings	
8. Maintenance	19
9. Warranty and Services	20

Introduction 1

Core Insight, Inc. is an ionization system manufacturer and supplier to ESD and contamination control application. Core Insight, Inc. also provides ESD Test and Measurement equipment, Professional Static Auditing Kits, EMI Noise Filters and EOS/ESD Technical Services such as ESD Training, Process Assessment, ESD Control Program Development and Product Qualification Testing per ANSI/ESD Standards.

Core Insight, Inc. is a leading company for ESD and contamination control in the fields of semiconductors, flat panel displays, automotive, and general electronic manufacturing industries. Core Insight, Inc. was founded in 2003 and business partnership with ProStat Corporation, ON Filter, Monroe Electronics, Electro-Tech Systems, and Dangelmayer Associates etc.

2 Ionization and Application

A. Ionization Theory

Ionization solution has been used many years in electronic industry. Electrical ionization technology is most common design for many applications. Some ionizers designed for ESD application and some of them are contamination control in high technology manufacturing environment. Both are different purpose and may not work in both applications. Follows are the brief summary of differences and user guide for each applications.

B. Cleanroom Contamination Application

Electric field is one of strong force to attract particles on wafer, glass panel, printed circuit board and other insulator materials. To minimize this force, room ionization is the best solution in high technology and other cleanroom environment.

Pulsed DC ionization technology is the well known solution over many years to minimized air borne particle attraction in cleanroom environment. Using with laminar flow, generated ions can move long distance and wide coverage areas. This will significantly reduce the force between particles and sensitive devices such as wafer, flat panel display and medical items. In results, room ionization improves product yields and less losses.

C. ESD Control Application

Voltage (or Potential) difference is the reason why ESD event occurs and lead to device damage. Ionizer makes this voltage difference to the same or minimize the level between objects to avoid ESD damage or make it happen at the safe level.

Steady-State DC ionizer is provide high ion current to objects and maintain low peak (or offset) voltage on it. This makes minimize ESD risk in production and suitable for CDM ESD control in control program.

2 Ionization and Application

CoreStat® Self-Balanced Ionizers developed based on steady-state DC technology and upgraded the ground isolated power circuit design. It can maintain low peak (or offset) voltage performance by intrinsic balancing circuit design with longer maintenance cycle time. It does not require calibration or adjust to maintain low offset voltage and it needs to cleaning emitter points for decay performance.

D. AC Ionizations and Application

Core Insight, Inc. provides several AC ionization systems. Conventional AC ionizer for industrial applications such as roll to roll or winding & unwinding of paper, film and non-ESD sensitive areas. Bipolar Pulsed AC ionizer is output parameter adjustable technology to meet each application requirements. High Frequency AC has adopt piezo crystal power supply for neutralize charge on insulative materials in small package. AC ionizer generates more Ozone than DC in the environment and may cause of side effects in sensitive device handling areas.

All ionizers performed and tested per ANSI/ESD STM3.1 and other documents such as ANSI/ESD SP3.3, ANSI/ESD SP3.4 and ANSI/ESD SP3.5.

For more detail information about ionizer solution and technical support needed, please feel free to contact our sales representative at sales@coreinsight.co.kr or your local contacts.

3 Application Guide

A. Basic ESD Control

Basic ESD control is mandatory required to electronic industry. It follows simple principle to make equipotential between ESD sensitive items. Personal grounding, ESD safe worksurfaces and ESD safe packaging materials are the key control items in ESD protected area.

B. Ionization for CDM/CBE Controls

Due to automated process in high technology manufacturing environment, Charged Device Model (CDM) or CDM-like ESD damage becoming a major portion of device failures. Industry Council agreed to reduction of CDM protection target level down to 125V level and will impact basic level of ESD control program and organization. Not only CDM, but also Charge Board Event (CBE) like ESD issues are increasing due to device complexity and stored large amount of charge on printed circuit board.

Strategic guidance has been proposed by the EOS/ESD Association. Lowering device charged voltage level and increasing resistance of contact materials are the key strategic elements to prevent or minimize ESD damage.

ANSI/ESD S20.20 standard requires maximum allowable field strength is 125 V/inch for 200 V CDM device. Low peak (or offset) voltage of ionizer performance is important for ESD sensitive device control and control program per S20.20 based.

Core Insight, Inc. provides intrinsic low peak balancing Steady-State DC Ionizers for CDM ESD control with less maintenance.

For more detail information about ionizer solution and technical support needed, please feel free to contact our sales representative at sales@coreinsight.co.kr or your local contacts.

Cautions and Personal Safety 4

A. Cautions

Use of proper input voltage to avoid damaging the system.

Verify the cabling and its connection between controller, junction box and individual ceiling emitters before turn on the system.

Disconnection cable from ceiling emitters will damage the system.

Do not clean emitter point while the system is powered. This may result of additional contamination issue and possible electrical shock.

Do not open the system by un-authorized personnel while the system is powered. This will void the warranty and may result in additional cost.

B. Personal Safety

Before performing any maintenance on emitter points, it is highly recommended turn-off the system. Allow few minutes for high voltage power supplies to discharge.

5 Technical Specification

Input Voltage	24 VAC
Ion Emission	Pulsed DC Technology
Ion Balance	User Defined
Emitter Point	Single Crystal Silicon / Titanium
Display	3 Digit LED Display / 2 Color LED
Control	Output Voltage, On/Off Time Adjustment for each polarity
Alarm	LED Alarms for Cleaning, Power and Polling LED: Alarm display Audio: Cleaning, Power Failure and Polling
Output Monitoring	Normal Open Relay based Output Signal for Model 6320 and 6340 Controller
Material	Enclosure: ABS, Rod: Polycarbonate-ABS
Operating Environment	Temperature: 15~35°C Humidity: 30~60% RH
Dimensions	500W x 46H x 42D mm
Option	IR Remote Controller
Warranty	2 years

Drawing 6

Various length of Rods (A) and custom length are available from 125 mm to 900 mm

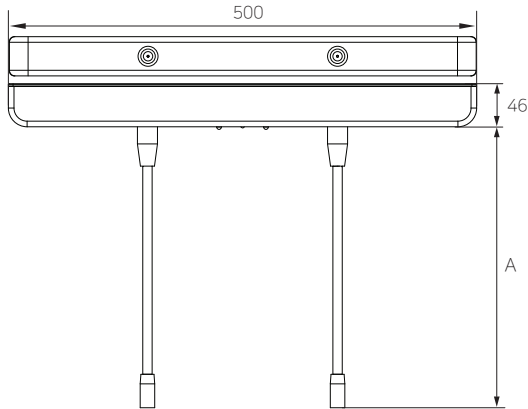

Lengths 'A' defined below

Setup and Operation 7

A. Introduction

Model 2300 AirStat® digital ceiling emitter ionizer is designed to control electrostatic fields in open areas such as ballroom, mini-environments, laminar flow hoods and workstations. Model 2300 digital ceiling emitter ionizer using pulsed DC technology and uniform ionization.

All output parameters can adjustable through Model 5711R IR Remote controller and communicating with Model 6320 and 6340 controllers.

7 Setup and Operation

B. Description of Model 2300 Ceiling ionizer

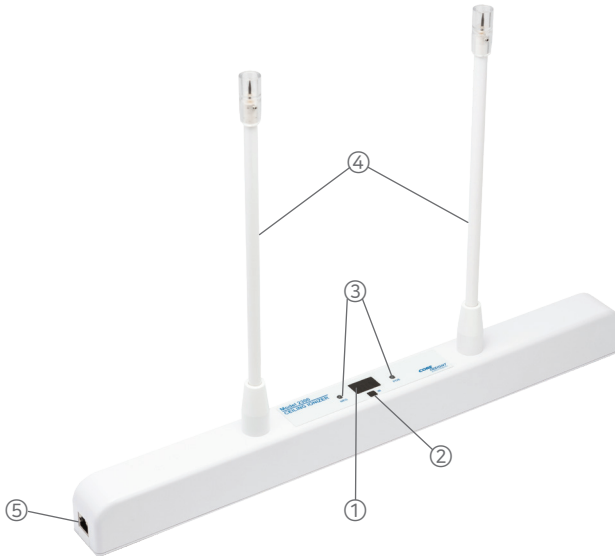

- ① LED: 3 digit display. Setting output parameter values and alarm level.
- ② IR Receiver: Communicate with Model 5711R remote controller.
- ③ Positive and Negative LED: Indication for normal operation (Green) and color change to Red for alarm status.
- ④ Emitter rods: Rods are replaceable and various length.
- ⑤ RJ-11 Terminal: Communication between controller and emitters or through junction box to emitters. Daisy-chained connection provides through RJ-11 terminal.

7 Setup and Operation

C. Description of Model 6380 Controller



- ① Power: Cord input, on/off switch and input fuse selector
- ② LED: 3 digit display. Setting output parameter values and alarm.
- ③ Normal and Alarm LED: Indication for normal operation (Green) and Red for alarm status.
- ④ Circular Metal Connector (CMC): Communication terminal to emitters or junction box.
- ⑤ Output Status: Relay Signal to external FMS systems. RJ-45 Ethernet cable.
- ⑥ Model 5711R Remote Controller

D. Installation

Stainless steel brackets and other mounting methods are determined by user. Determine locations of ceiling emitters, controller and then junction boxes at technical limitation between emitters. Recommended primary communication cable (20 AWG) length is 10 meters from controller to the first junction box or ceiling emitter. Recommended RJ-11 communication cable (24 AWG) from junction box to ceiling emitter or between ceiling emitters are 5 meters and maximum overall length are 45 meters for 10 units of ceiling emitters.

7 Setup and Operation

Communication cable must be tested and verified during installation at each desired locations. All cables are test for open, short and color matching. From controller to junction with daisy-chained wiring should be all straight connection at junction box terminal.

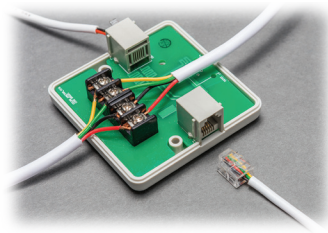

Junction Box Wiring

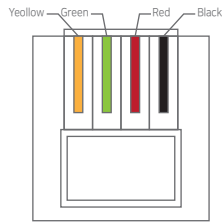

RJ-11 Terminal Wiring

Link IN - Wiring Cable		
No.	Color	Description
1	BLACK	AC Return
2	RED	Power VAC
3	GREEN	RS485A
4	YELLOW	RS485B



Rod Stabilizing Spacer



Installation Example

Emitter rods are removable and shipped uninstalled with the emitter. To install the rods, insert the end of the rod into receptacle on the emitter and rotate the rod 1/4 turn clockwise until it hits the stop. Rod stabilizing spacer provides support for emitter rods 600mm or longer.

Cautions

Do not connect or disconnect emitters while the controller is powered!
 Emitter rods are installed on all emitters.
 Emitters are properly connected to the controller.

7 Setup and Operation

E. Powering the System

Once all systems in place and connected properly, turning on the controller. When ceiling emitters and controller are powered, start LED display and communication. Remote controller can assign ID address at each ceiling emitters. Appropriate address can be assign between #01 and #80 without duplicated number. Controller will scan ID addresses.

F. Output Settings

Once all ceiling emitters are powered, it will operate at the factory default mode. All ceiling emitters can be set differently to satisfy different operating environments or needs within the same area.

Following sections described functions and features of ceiling emitters on LED display. User can select operation on/off, high voltage on & off time for both polarity, high voltage output levels by 0.1kV resolution, cleaning alarm settings, power alarm setting and ID address.

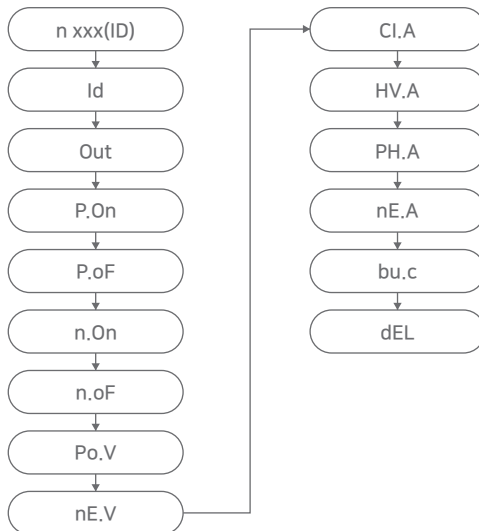







7 Setup and Operation

To start communicating at each ceiling emitter, press START and ID address on Model 5711R remote controller. Press FUN button for select output parameters. LED will display as below and all parameters can be adjustable by UP/DOWN. Once user changed any parameter, press FUN to store value in memory and make changed value operational.



1) Remote Controller

User can adjust parameters from remote controller.

-  Press START to adjust parameters
-  Press FUN to parameter modes and save value
-  Press NEXT to move next parameter mode
-  Press UP to increase selected parameter value
-  Press DOWN to decrease selected parameter value
-  User selectable value input from 0 to 9 for voltage and time
-  Parameter adjustment finished, press END for exit.

*If user did not press FUN, adjusted value will not store and back to previous set value.

2) ID Address

Press FUN and UP/DOWN or press any number for set ID address on remote controller in three digits such as 01 or 80. LED will display as below.

Press FUN to store this ID set.



7 Setup and Operation

3) Output On/Off

Press FUN and NEXT, output On/Off parameter will display.

On is factory default set for initial enable mode. Press UP/DOWN to change individual ceiling emitter on or off. Press FUN to store this set.



4) Positive Voltage On and Off Time

Press FUN and NEXT (2 times). P.On will display.

3.5 sec is factory default set value. Press UP/Down or type numeric value up to 10.0 seconds maximum. Press FUN to store this set value.



Press FUN and NEXT (3 times). P.oF will display.

0.0 sec is factory default set value. Press UP/DOWN or type numeric value up to 5.0 seconds maximum. Press FUN to store this set value.



5) Negative Voltage On and Off Time

Press FUN and NEXT (4 times). n.On will display.

3.5 sec is factory default set value. Press UP/Down or type numeric value up to 10.0 seconds maximum. Press FUN to store this set value.



Press FUN and NEXT (5 times). n.oF will display.

0.0 sec is factory default set value. Press UP/DOWN or type numeric value up to 5.0 seconds maximum. Press FUN to store this set value.



7 Setup and Operation

6) Voltage Adjustment

Press FUN and NEXT(6 times). Po.V will display.

7.0 kV is factory default set value. Press UP/DOWN or type numeric value up to 10.0 kV seconds maximum. Press FUN to store this set value.

880 ▶ P80 ▶ 880 ▶ 880

Press FUN and NEXT (7 times). NE.V will display.

-7.0 kV sec is factory default set value. Press UP/DOWN or type numeric value up to -10.0 kV seconds maximum. Press FUN to store this set value.

880 ▶ NEU ▶ 880 ▶ 880

7) Cleaning Cycle Alarm Setting

Press FUN and NEXT (8 times). Cl.A will display. Off is factory default set as disable cleaning cycle indication mode. Press UP/DOWN to adjust cleaning cycle option from off to on.

880 ▶ 01A ▶ 0FF ▶ 880

Press NEXT, then user can adjust cleaning frequency from 1 day to 60 days option. Press UP/DOWN to adjust value and press FUN to store.

880 ▶ 01A ▶ 880

*It is recommend to cleaning emitter point at every 60 days cycle.

8) High Voltage Power Failure Alarm on/off set

Press FUN and NEXT (10 times). HV.A will display. Off is factory default set as disable alarm mode. Press UP/DOWN to adjust set from off to on. Press FUN to store. High voltage power failure alarm mode has been On status now.

880 ▶ HVA ▶ 0FF ▶ 880

7 Setup and Operation

10) High Voltage Power Alarm Level set

Press FUN and NEXT (11 times). PH.A will display.

After user changes the HVP alarm mode to On, positive factory default set range applied as $\pm 20\%$ value.

PH.A ▶ PH.A ▶ 88.4 ▶ 88.0

Press FUN and NEXT (12 times). nH.A will display.

After user changes the HVN alarm mode to On, negative factory default set range applied as $\pm 20\%$ value.

nH.A ▶ nH.A ▶ 88.4 ▶ 88.0

*If user want to set it to other value, type numeric value on remote controller.

11) Audio Alarm on/off

Press FUN and NEXT (13 times). bu.c will display. Off is factory default set as disable mode. Press UP/DOWN to adjust set from off to on mode.

Press FUN to store.

bu.c ▶ bu.c ▶ OFF ▶ 88.0

12) ID Delete and Change

If user wants to disable one of ceiling emitter from controller or change address ID, Press FUN and NEXT (14 times). dEL will display. Press UP/DOWN to adjust set from off to on mode. Press FUN to store.

dEL ▶ dEL ▶ OFF ▶ 88.0

8 Maintenance

Warning

There are no user-serviceable parts inside the controller or emitter. Any unauthorized service will void the warranty and may result in additional repair charge.

General Maintenance Information

Emitter point maintenance ensures continued performance of ceiling emitter ionization. Dirt or erosion to emitter points can be caused by a number of environmental factors, including airborne molecular contamination issue.

Before cleaning or removing emitter points, the ceiling emitter must be powered down by turn off the controller or change to off status on controller.

Step 1. Recommended Cleaning Materials:

- 1) Cleanroom-compatible cloth or wipe
- 2) Cleanroom approved swabs (foam is not recommended)
- 3) Cleaning solution of 50% isopropyl alcohol (IPA) and 50% deionized water mixture

Caution

Do not clean emitter points while the unit is powered. Doing so may result in additional contamination and possible shock. After removing power from the emitter, allow few minutes for high voltage power supplies to discharge.

Step 2. Cleaning the Emitter Points

Turn off the ceiling emitter. Clean the emitter points and areas around the emitter points, moisten a cleanroom-compatible swab or cleaning cloth in the IPA solution, or use cleaning solution from Core Insight. Gently rotate the swab or cleaning cloth around the emitter point. After cleaning allow the emitter points for dry out about 20 minutes. Turn on the system.

Warranty and Service 9

Core Insight, Inc. provides a limited warranty for all ionizers. New products manufactured or sold by Core Insight, Inc. are guaranteed to be free from defects in material or workmanship for a period of defined schedules from the date of initial shipment. Core Insight, Inc.'s liability under its new product warranty is limited servicing (evaluating, repairing or replacement) any unit returned from customers that has not been subjected to misuse, neglect, lack of routine maintenance, repair, alteration or accident. In no event shall Core Insight, Inc. be liable for collateral or consequential damages.

To obtain service under this warranty, please contact sales representative at sales@coreinsight.co.kr or local contacts.



